

$$\frac{10.114}{^{12}\text{B} + \alpha}$$

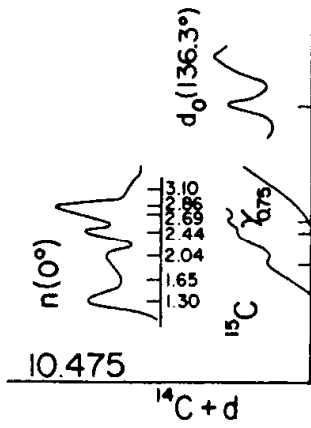

$$\frac{4.843}{^{14}\text{N} + t - p}$$

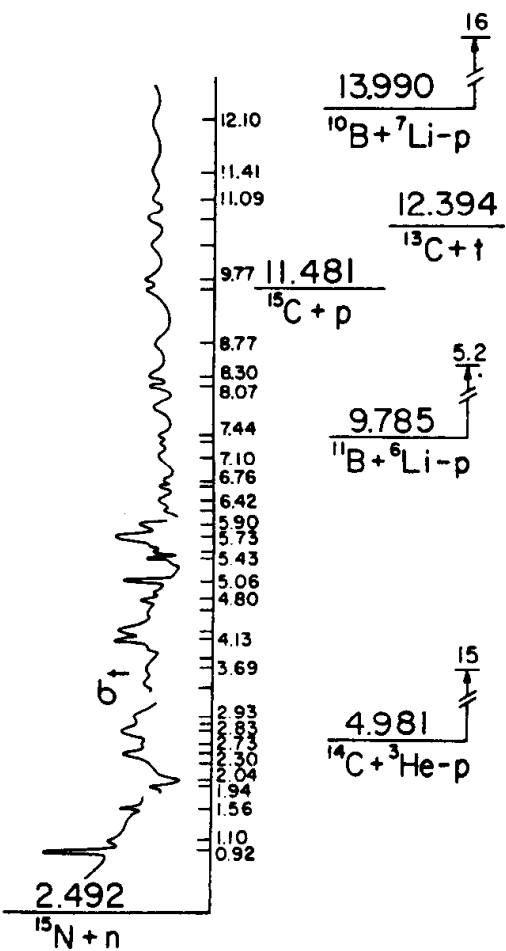
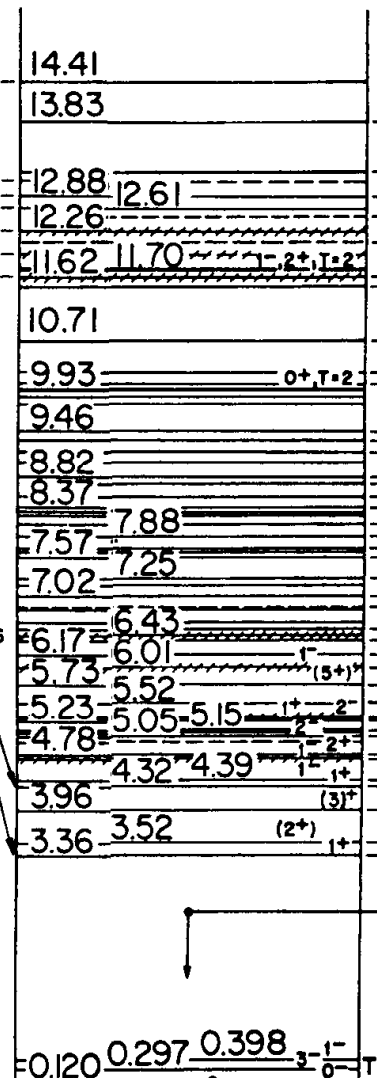
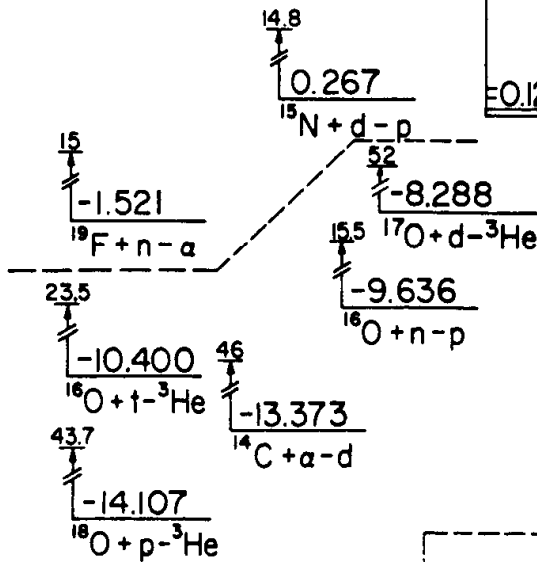
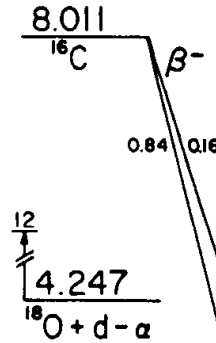

16N

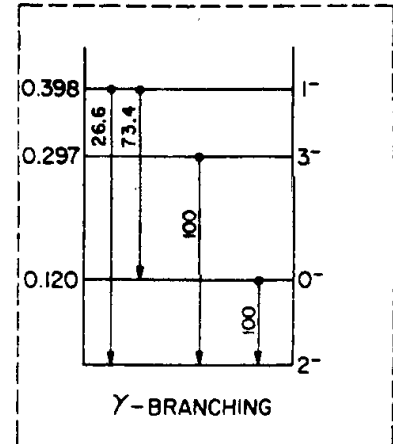
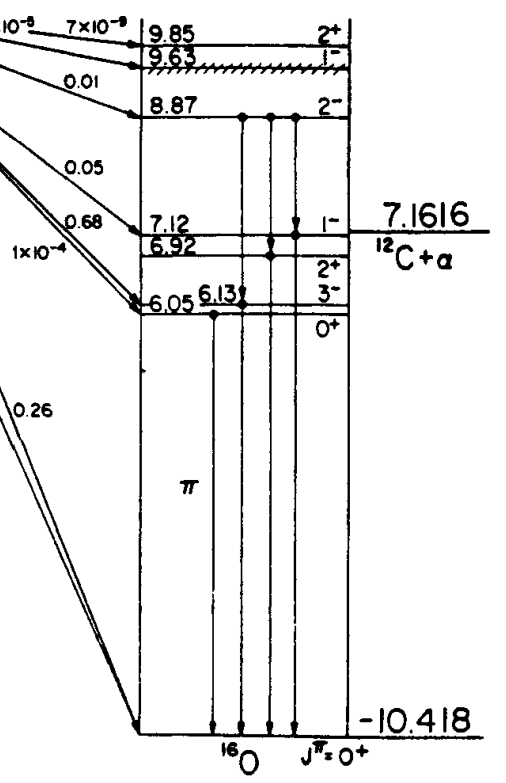

Y-BRANCHING